



P
O
W
E
R
M
I
X



DIET
FEEDERS



Shelbourne CONTENTS

INDEX	PAGE
ABOUT SHELBOURNE REYNOLDS.....	3
HISTORY.....	4
WHAT MAKES POWERMIX UNIQUE?.....	5
POWMIX PRO POPULAR (9-15 cu m).....	6-9
POWMIX PRO EXPRESS - SINGLE AUGER (9-15 cu m).....	10-13
POWMIX PRO EXPRESS - TWIN AUGER SINGLE AXLE (16-19 cu m).....	14-17
POWMIX PRO EXPRESS - TWIN AUGER TANDEM AXLE (16-25 cu m).....	18-19
POWMIX PLUS - COMPACT (16-20 cu m).....	20-23
POWMIX PLUS - COMPACT (16-22 cu m).....	24-25
POWMIX PLUS - WIDE BODY (22-30 cu m).....	26-29
POWMIX BIO STATIC.....	30-31
POWMIX TYRE OPTIONS.....	32-33
POWMIX SCALE & HYDRAULIC CONTROL OPTIONS.....	34
POWMIX AUGER SPEEDS.....	35

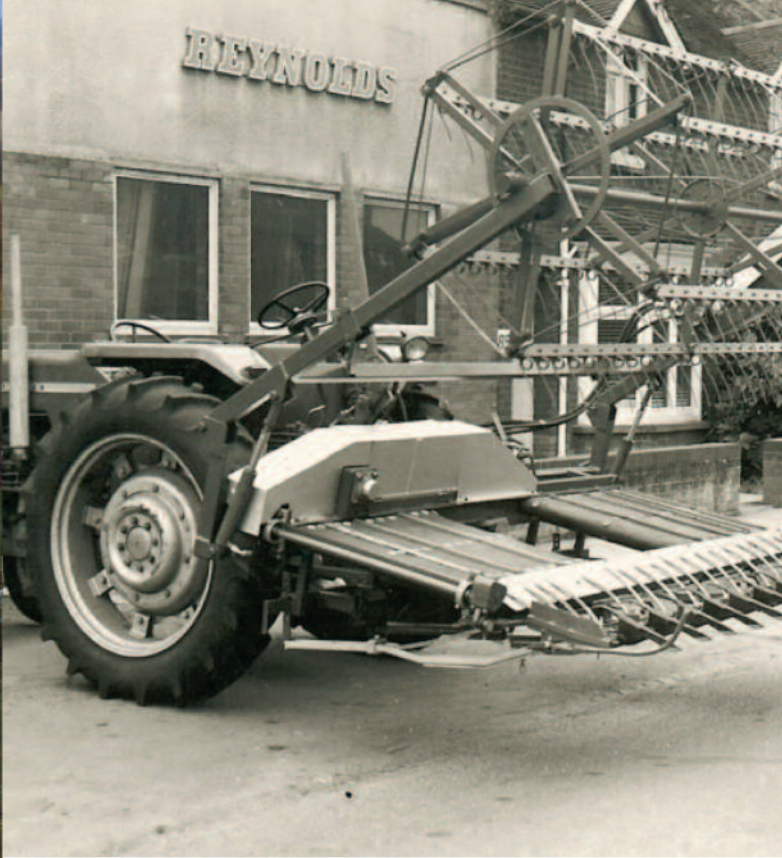

OVER **FOUR DECADES** OF FARM MACHINERY

FOUNDED IN 1972, SHELBOURNE REYNOLDS HAS BEEN A FIXTURE IN AGRICULTURAL EQUIPMENT MANUFACTURING EVER SINCE.

Today, we are located on the same site in Stanton, near Bury St Edmunds, Suffolk, where we were established – but our business continues to grow. Our factory now covers over 12,000 sq m of the two hectare premises on which we are based, and employs 150 people.

Here, we use the latest design software to create the machines our markets demand, and utilise some of the most sophisticated manufacturing equipment available to produce not only Powermix diet feeders, but also Shelbourne hedge/verge trimmers, Powerspread manure spreaders and a host of other arable, livestock and groundcare machinery.

Our manufacturing technology includes CNC machining centres, laser steel cutting machines and one of the UK's largest powder coat paint facilities. All of this means we are able to create in-house, to extremely high standards, a large proportion of the components required for our equipment, using processes including machining and gear cutting to manufacture specific drives for specific applications.

With Shelbourne Reynolds equipment, there's no question of compromising machine performance or longevity by using lower spec cheaper components. That means our dealers and customers benefit from knowing that we put our name to every key component of our equipment.



A PROVEN HISTORY IN FEEDER PRODUCTION

EXPERIENCE IS AN ESSENTIAL ELEMENT OF RELIABLE DESIGN, AND WITH A HISTORY OF DIET FEEDER PRODUCTION STRETCHING BACK MORE THAN 25 YEARS, YOU CAN BE SURE SHELBOURNE REYNOLDS HAS JUST THAT.

Our first Powermix models were introduced in 1994. Since then, our focus has always been on the bale processing capabilities, positive mixing action and low horsepower requirements of auger-based machines.

But as farms have expanded and herd sizes have grown, our engineers have kept pace by designing new, higher capacity models with faster mixing and feed-out times. Today, the Powermix range spans models with capacities from 9-46 cubic metres, with augers and feed-out systems built to match specific capacity sectors.

Read on to find out how the characteristics we design into our feeders can help you to get more from your feed, no matter what the size of your enterprise.



AUGER DESIGN

STANDARD STEPPED AUGER

- Fitted to all Powermix Pro models



SMOOTH SCROLLED AUGER

Fitted to Powermix Plus (Compact) models

- Design offers greater wear resistance
- Features replaceable wear pads



HEAVY DUTY STEPPED AUGER

Fitted to Powermix Plus (Wide) models

- 15mm S500 auger flight
- 15mm stainless steel edging
- Replaceable wear pads



FEED-OUT OPTIONS

POWERMIX PRO POPULAR HYDRAULIC SIDE DOOR

- Suited to on-floor or shallow trough systems



POWERMIX PRO EXPRESS FIXED FRONT CONVEYOR

- Variable-speed conveyor belt suited to feeding to the left or right



POWERMIX PRO EXPRESS ELEVATING FRONT CONVEYOR

- Variable speed conveyor belt for feeding to the left or right into raised troughs



POWERMIX POPULAR

9, 11, 13 & 15m³ Single Auger - Side Discharge

BIG IN FEATURES.

Our entry-level line, the Powermix Pro Popular, comprises of four models and features a simple hydraulic right front corner feed out door suitable for floor feeding or low level troughs. An optional rear left corner door is available to feed out on both sides.

THE RANGE	VOLUME	AXLE SPEC	TYRE SPEC
POWERMIX PRO POPULAR 9	9m ³	SINGLE FIXED	385/55 R19.5
POWERMIX PRO POPULAR 11	11m ³	SINGLE FIXED	385/55 R19.5
POWERMIX PRO POPULAR 13	13m ³	SINGLE FIXED	385/55 R19.5
POWERMIX PRO POPULAR 15	15m ³	SINGLE FIXED	385/55 R19.5



KEY FEATURES

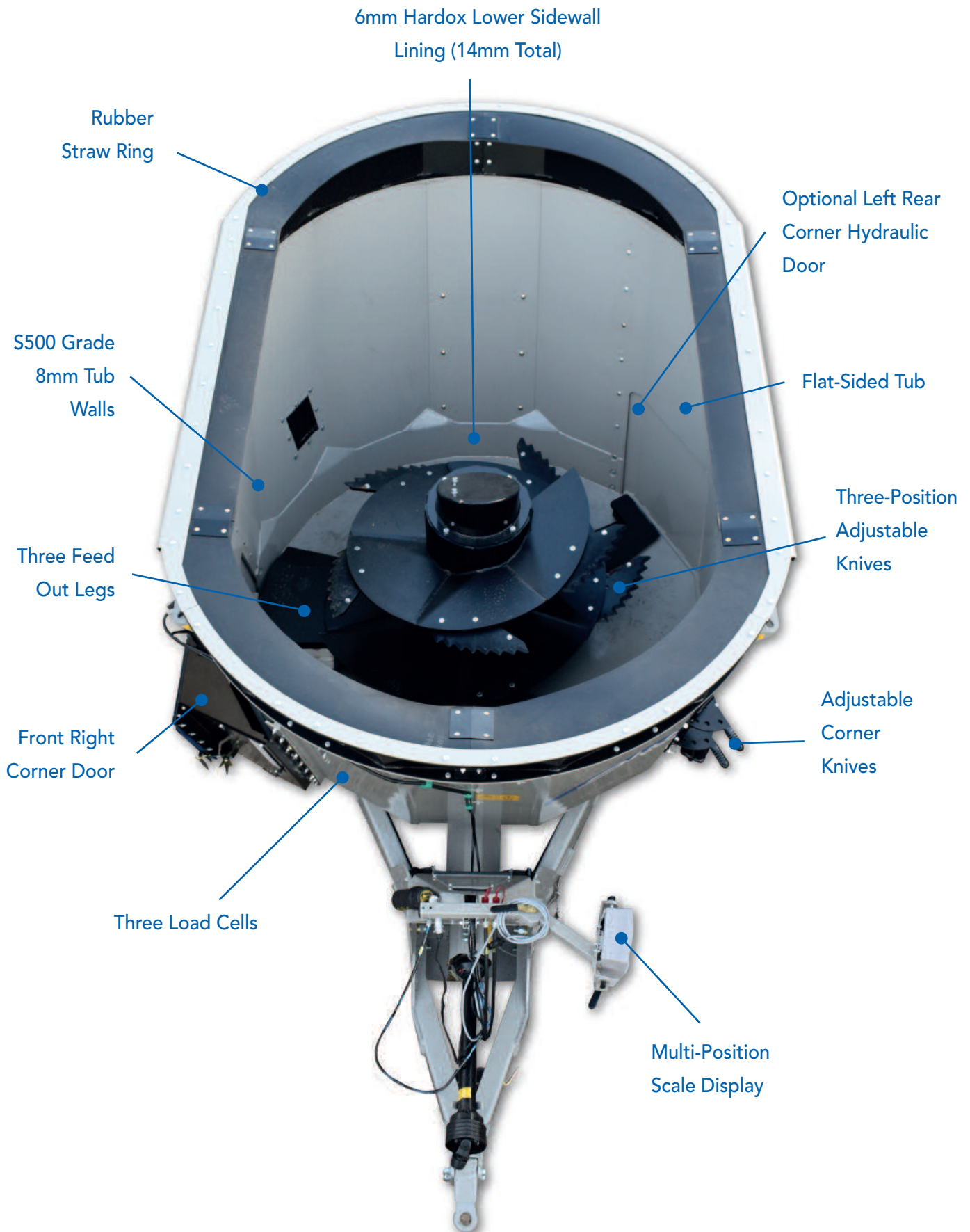

POWERMIX POPULAR

9-15m³ Single Auger - Side Discharge

STANDARD FEATURES & OPTIONS

STANDARD FEATURES	9M	11M	13M	15M
CAPACITY / LEVEL	4500 kg*	5500 kg*	6500 kg*	7500 kg*
VOLUME / LEVEL	9m ³	11m ³	13m ³	15m ³
TYRE SIZE	385/55R19.5	385/55R19.5	385/55R19.5	385/55R19.5
PTO SPEED	540 rpm	540 rpm	540 rpm	540 rpm
HP REQUIRED	85	90	100	120
UNLADEN WEIGHT	3780 kg	4040 kg	4205 kg	4365 kg
DOOR CONFIGURATION	SINGLE RIGHT FRONT CORNER DOOR			
DOOR OPERATION	HYDRAULIC	HYDRAULIC	HYDRAULIC	HYDRAULIC
HYDRAULIC BRAKES	STD	STD	STD	STD
LED LIGHTS	STD	STD	STD	STD
ADJUSTABLE CORNER KNIVES	STD	STD	STD	STD
RUBBER STRAW RETAINING RING	STD	STD	STD	STD
HYDRAULIC CONTROL	HOSES DIRECT TO TRACTOR			
NUMBER OF LOAD CELLS	3	3	3	3
NUMBER OF AUGERS	1	1	1	1
NUMBER OF BLADES	7	7	10	11
AUGER MAGNET	STD	STD	STD	STD
OPTIONS				
LH REAR CORNER DOOR (DIRECT COUPLED HYD)	OPT	OPT	OPT	OPT
MANUAL VALVE HYD CONTROL	OPT	OPT	OPT	OPT
DG400 BASIC SCALE SYSTEM	OPT	OPT	OPT	OPT
DG600 PROG. SCALE SYSTEM	OPT	OPT	OPT	OPT
DG REMOTE ZERO	OPT	OPT	OPT	OPT
DG GPRS DATA TRANSFER KIT	OPT	OPT	OPT	OPT
BATTERY PACK FOR SCALE	OPT	OPT	OPT	OPT
TWO SPEED GEARBOX	OPT	OPT	OPT	OPT
WIDE ANGLE PTO	OPT	OPT	OPT	OPT
425/40 R17 TYRE	OPT	OPT	N/A	N/A
TUB RISER KIT (INC 385/65R22.5 SUPER SINGLES)	OPT	OPT	OPT	OPT
TUNGSTEN BLADES	OPT	OPT	OPT	OPT

* DEPENDING UPON FEED DM%

DIMENSIONS

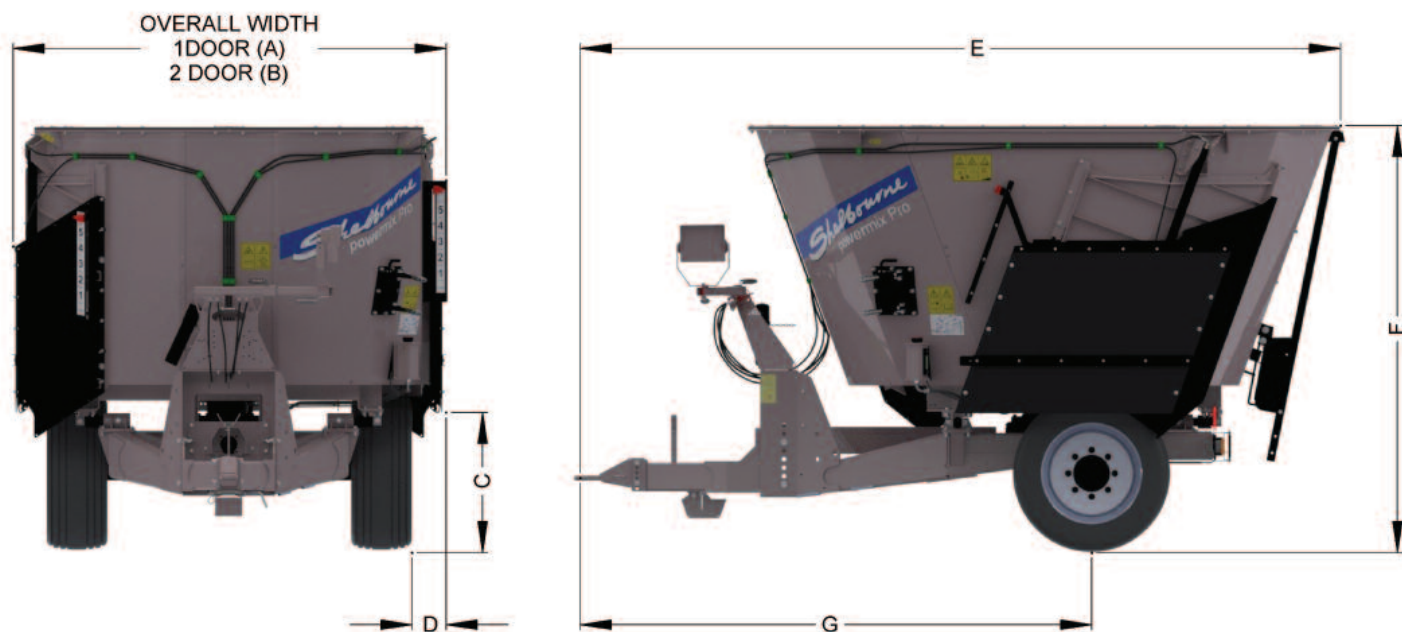
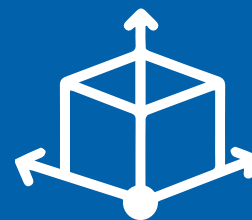

	A	B	C	D	E	F	G
9m ³	2458 mm 8'	2600 mm 8'5"	740 mm 2'4"	330 mm 1'	4605 mm 15'1"	2515 mm 8'2"	3105 mm 10'1"
11m ³	2458 mm 8'	2600 mm 8'5"	740 mm 2'4"	330 mm 1'	4715 mm 15'4"	2815 mm 9'2"	3105 mm 10'1"
13m ³	2458 mm 8'	2600 mm 8'5"	740 mm 2'4"	330 mm 1'	4825 mm 15'8"	3115 mm 10'2"	3105 mm 10'1"
15m ³	2458 mm 8'	2600 mm 8'5"	740 mm 2'4"	330 mm 1'	4935 mm 16'1"	3315 mm 10'8"	3105 mm 10'1"

POWERMIX PRO EXPRESS

9, 11, 13 & 15m³ - Single Auger

FIXED OR ELEVATING FRONT CONVEYOR.

Like the Powermix Pro Popular, the single-auger Powermix Pro Express range features a tall auger for quick, efficient mixing and three feed legs for fast, even feed-out.

Choose from 9-15m³ capacity models. The front-mounted Express conveyor is available as a fixed unit for feed delivery to either side, or an elevating conveyor for dispensing into raised troughs to both sides.

THE RANGE	VOLUME	AXLE SPEC	TYRE SPEC
POWERMIX PRO EXPRESS 9	9m ³	SINGLE FIXED	385/55 R19.5
POWERMIX PRO EXPRESS 11	11m ³	SINGLE FIXED	385/55 R19.5
POWERMIX PRO EXPRESS 13	13m ³	SINGLE FIXED	385/55 R19.5
POWERMIX PRO EXPRESS 15	15m ³	SINGLE FIXED	385/55 R19.5



KEY FEATURES

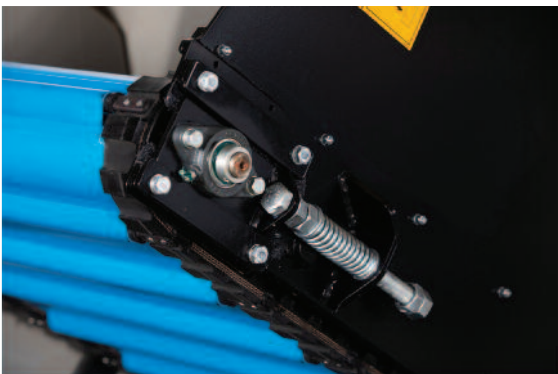

POWERMIX PRO EXPRESS

9-15m³ Single Auger

STANDARD FEATURES & OPTIONS

STANDARD FEATURES	9M	11M	13M	15M
CAPACITY / LEVEL	4500 kg*	5500 kg*	6500 kg*	7500 kg*
VOLUME / LEVEL	9m ³	11m ³	13m ³	15m ³
TYRE SIZE	385/55R19.5	385/55R19.5	385/55R19.5	385/55R19.5
PTO SPEED	540 rpm	540 rpm	540 rpm	540 rpm
HP REQUIRED	95	100	110	120
UNLADEN WEIGHT	4100 kg	4360 kg	4525 kg	4685 kg
DOOR CONFIGURATION	FRONT CENTRE DOOR AND FRONT WEBBING CONVEYOR			
DOOR OPERATION	HYDRAULIC	HYDRAULIC	HYDRAULIC	HYDRAULIC
HYDRAULIC BRAKES	STD	STD	STD	STD
LED LIGHTS	STD	STD	STD	STD
ADJUSTABLE CORNER KNIVES	STD	STD	STD	STD
RUBBER STRAW RETAINING RING	STD	STD	STD	STD
HYDRAULIC CONTROL	HOSES DIRECT TO TRACTOR			
NUMBER OF LOAD CELLS	3	3	3	3
NUMBER OF AUGERS	1	1	1	1
NUMBER OF BLADES	7	7	10	11
AUGER MAGNET	STD	STD	STD	STD
OPTIONS				
MANUAL VALVE HYD CONTROL	OPT	OPT	OPT	OPT
ELECTRIC HYD CONTROL	OPT	OPT	OPT	OPT
ELEC. CONTROL <small>WITH VARI SPEED CONVEYOR</small>	OPT	OPT	OPT	OPT
DG400 BASIC SCALE SYSTEM	OPT	OPT	OPT	OPT
DG600 PROG. SCALE SYSTEM	OPT	OPT	OPT	OPT
DG REMOTE ZERO	OPT	OPT	OPT	OPT
DG GPRS DATA TRANSFER KIT	OPT	OPT	OPT	OPT
REMOTE SCALE HEAD	OPT	OPT	OPT	OPT
BATTERY PACK FOR SCALE	OPT	OPT	OPT	OPT
TWO SPEED GEARBOX	OPT	OPT	OPT	OPT
WIDE ANGLE PTO	OPT	OPT	OPT	OPT
425/40 R17 TYRE	OPT	OPT	N/A	N/A
TUB RISER KIT <small>(INC 386/65R22.5 SUPER SINGLES)</small>	OPT	OPT	OPT	OPT
TUNGSTEN BLADES	OPT	OPT	OPT	OPT
REAR CENTRE DOOR	N/A	N/A	N/A	N/A
CORNER REAR DOOR	N/A	N/A	N/A	N/A

* DEPENDING UPON FEED DM%

DIMENSIONS

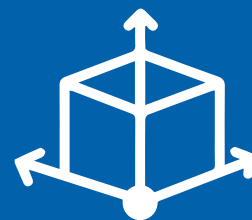

	A	B	C	D	E	F	G
9m ³	2730 mm 9'	2350 mm 7'9"	5300 mm 17'7"	2515 mm 8'3"	1425 mm 4'8"	470 mm 1'7"	3690 mm 12'8"
11m ³	2730 mm 9'	2350 mm 7'9"	5410 mm 18"	2815 mm 9'3"	1425 mm 4'8"	470 mm 1'7"	3690 mm 12'8"
13m ³	2730 mm 9'	2350 mm 7'9"	5520 mm 18'4"	3115 mm 10'3"	1425 mm 4'8"	470 mm 1'7"	3690 mm 12'8"
15m ³	2730 mm 9'	2350 mm 7'9"	5630 mm 18'9"	3315 mm 11'3"	1425 mm 4'8"	470 mm 1'7"	3690 mm 12'8"

POWERMIX PRO EXPRESS

16, 19, 22 & 25m³ - Twin Auger

FIXED OR ELEVATING FRONT CONVEYOR.

With the twin auger Powermix Pro Express models, you get the specification to handle higher daily feed-out demands, with options such as sprung tandem axles, plus capacities of up to 25m³. But the same tall auger design means you still get Shelbourne's trademark speedy yet thorough mixing, and the three feed legs again help ensure even feed-out.

THE RANGE	VOLUME	AXLE SPEC	TYRE SPEC
POWERMIX PRO EXPRESS 16 SA	16m ³	SINGLE FIXED	435/50 R19.5
POWERMIX PRO EXPRESS 16 TA	16m ³	SPRUNG TANDEM	385/55 R22.5
POWERMIX PRO EXPRESS 19 SA	19m ³	SINGLE FIXED	435/50 R19.5
POWERMIX PRO EXPRESS 19 TA	19m ³	SPRUNG TANDEM	385/55 R22.5
POWERMIX PRO EXPRESS 22 TA	22m ³	SPRUNG TANDEM	385/55 R22.5
POWERMIX PRO EXPRESS 25 TA	25m ³	SPRUNG TANDEM	385/55 R22.5



KEY FEATURES



POWERMIX PRO EXPRESS

16-19m³ Twin Auger - Single Axle

STANDARD FEATURES & OPTIONS

STANDARD FEATURES	16M	19M
CAPACITY / LEVEL	8000 kg*	9500 kg*
VOLUME / LEVEL	16m ³	19m ³
TYRE SIZE	435/50R19.5	435/50R19.5
PTO SPEED	540 rpm	540 rpm
HP REQUIRED	110	120
UNLADEN WEIGHT	8030 kg	8435 kg
DOOR CONFIGURATION	FRONT CENTRE DOOR & FRONT WEBBING CONVEYOR	
DOOR OPERATION	HYDRAULIC	HYDRAULIC
HYDRAULIC BRAKES	STD	STD
LED LIGHTS	STD	STD
ADJUSTABLE CORNER KNIVES	STD	STD
RUBBER STRAW RETAINING RING	STD	STD
HYDRAULIC CONTROL	HOSES DIRECT TO TRACTOR	
NUMBER OF LOAD CELLS	4	4
NUMBER OF AUGERS	2	2
NUMBER OF BLADES	14	14
TWO SPEED GEARBOX	STD	STD
AUGER MAGNET	STD	STD
OPTIONS		
ELECTRIC HYD CONTROL	OPT	OPT
ELEC. CONTROL WITH VARI SPEED CONVEYOR	OPT	OPT
MANUAL VALVE HYDRAULIC CONTROL	OPT	OPT
DG400 BASIC SCALE SYSTEM	OPT	OPT
DG600 PROG. SCALE SYSTEM	OPT	OPT
REMOTE SCALE HEAD	OPT	OPT
DG REMOTE ZERO	OPT	OPT
DG GPRS DATA TRANSFER KIT	OPT	OPT
BATTERY PACK FOR SCALE	OPT	OPT
ELEVATING FRONT CONVEYOR	OPT	OPT
FIXED FRONT CONVEYOR	OPT	OPT
WIDE ANGLE PTO	OPT	OPT
18R 22.5 TYRE	OPT	OPT
TUNGSTEN BLADES	OPT	OPT
REAR CENTRE DOOR	N/A	N/A
CORNER REAR DOOR	N/A	N/A

* DEPENDING UPON FEED DM%

DIMENSIONS

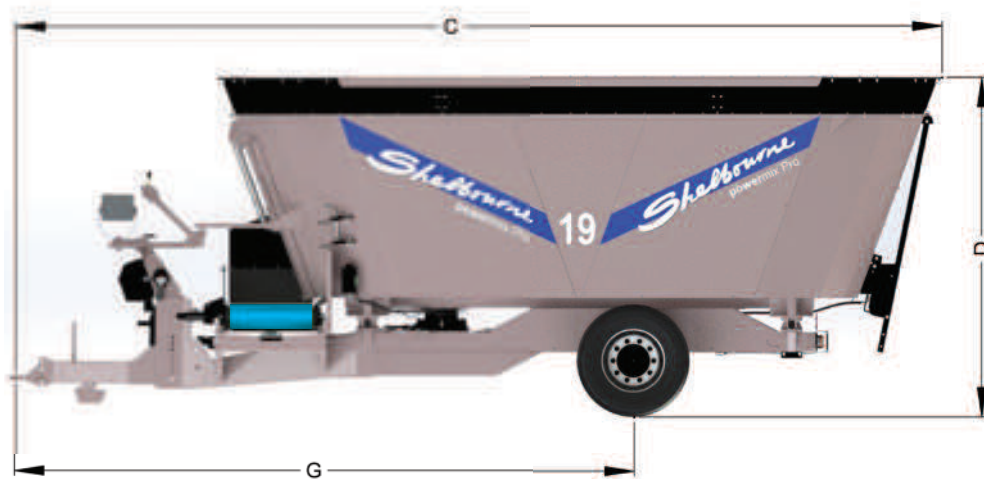
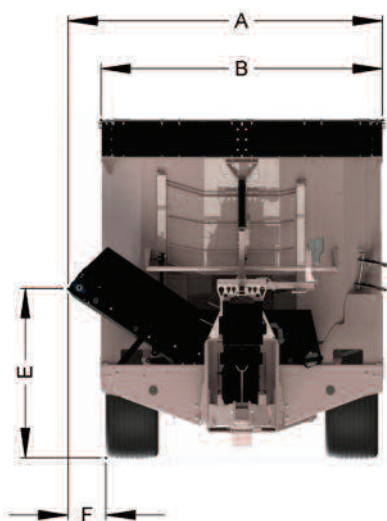
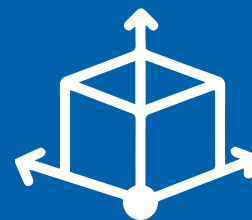

	A	B	C	D	E	F	G
16m ³ 18 R22.5	2730 mm 9'	2350 mm 7'9"	7580 mm 24'8"	2730 mm 9'	1670 mm 5'4"	415 mm 1'4"	5115 mm 16'7"
16m ³ 435/50 R19.5	2730 mm 9'	2350 mm 7'9"	7580 mm 24'8"	2520 mm 8'2"	1460 mm 4'7"	410 mm 1'3"	5115 mm 16'7"
19m ³ 18 R22.5	2730 mm 9'	2350 mm 7'9"	7690 mm 25'3"	3030 mm 9'9"	1670 mm 5'4"	415 mm 1'4"	5115 mm 16'7"
19m ³ 435/50 R19.5	2730 mm 9'	2350 mm 7'9"	7690 mm 25'3"	2820 mm 9'2"	1460 mm 4'7"	410 mm 1'3"	5115 mm 16'7"

POWERMIX PRO EXPRESS

16-25m³ Twin Auger - Tandem Axle

STANDARD FEATURES & OPTIONS

STANDARD FEATURES	16M	19M	22M	25M
CAPACITY / LEVEL	8000 kg*	9500 kg*	11000 kg*	12500 kg*
VOLUME / LEVEL	16m ³	19m ³	22m ³	25m ³
TYRE SIZE	385/55R19.5	385/55R19.5	385/55R19.5	385/55R19.5
AXLE TYPE	TANDEM SPRUNG			
PTO SPEED	540 rpm	540 rpm	540 rpm	540 rpm
HP REQUIRED	110	120	130	140
UNLADEN WEIGHT	8325 kg	8730 kg	8960 kg	9160 kg
DOOR CONFIGURATION	FRONT CENTRE DOOR AND FRONT WEBBING CONVEYOR			
DOOR OPERATION	HYDRAULIC			
HYDRAULIC BRAKES	STD	STD	STD	STD
LED LIGHTS	STD	STD	STD	STD
ADJUSTABLE CORNER KNIVES	STD	STD	STD	STD
RUBBER STRAW RETAINING RING	STD	STD	STD	STD
HYDRAULIC CONTROL	HOSES DIRECT TO TRACTOR			
NUMBER OF LOAD CELLS	4	4	4	4
NUMBER OF AUGERS	2	2	2	2
NUMBER OF BLADES	14	14	14	14
AUGER MAGNET	STD	STD	STD	STD
TWO SPEED GEARBOX	STD	STD	STD	STD
OPTIONS				
ELECTRIC HYD CONTROL	OPT	OPT	OPT	OPT
ELEC. CONTROL <small>WITH VARI SPEED CONVEYOR</small>	OPT	OPT	OPT	OPT
MANUAL VALVE HYD CONTROL	OPT	OPT	OPT	OPT
DG400 BASIC SCALE SYSTEM	OPT	OPT	OPT	OPT
DG600 PROG. SCALE SYSTEM	OPT	OPT	OPT	OPT
REMOTE SCALE HEAD	OPT	OPT	OPT	OPT
DG REMOTE ZERO	OPT	OPT	OPT	OPT
DG GPRS DATA TRANSFER KIT	OPT	OPT	OPT	OPT
BATTERY PACK FOR SCALE	OPT	OPT	OPT	OPT
ELEVATING FRONT CONVEYOR	OPT	OPT	OPT	OPT
FIXED FRONT CONVEYOR	OPT	OPT	OPT	OPT
WIDE ANGLE PTO	OPT	OPT	OPT	OPT
385/55R19.5 TYRES	OPT	OPT	OPT	OPT
435/50R19.5 TYRES	OPT	OPT	OPT	OPT
TUB RISER KIT <small>(INC 385/65R22.5 SUPER SINGLES)</small>	OPT	OPT	OPT	OPT
TUNGSTEN BLADES	OPT	OPT	OPT	OPT
REAR CENTRE DOOR	N/A	N/A	N/A	N/A
CORNER REAR DOOR	N/A	N/A	N/A	N/A
AIR BRAKES	OPT	OPT	OPT	OPT
STEERING AXLE (HYD BRAKES)	OPT	OPT	OPT	OPT
STEERING AXLE (AIR BRAKES)	OPT	OPT	OPT	OPT

* DEPENDING UPON FEED DM%

DIMENSIONS

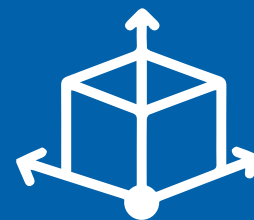

	A	B	C	D	E	F	G
16m ³	2730 mm 9'	2350 mm 7'9"	7580 mm 25'3"	2599 mm 8'5"	1500 mm 4'11"	465 mm 1'5"	5200 mm 17'
19m ³	2730 mm 9'	2350 mm 7'9"	7690 mm 25'8"	2899 mm 9'5"	1500 mm 4'11"	465 mm 1'5"	5200 mm 17'
22m ³	2730 mm 9'	2350 mm 7'9"	7800 mm 25'5"	3199 mm 10'4"	1500 mm 4'11"	465 mm 1'5"	5200 mm 17'
25m ³	2730 mm 9'	2350 mm 7'9"	7870 mm 25'8"	3399 mm 11'1"	1500 mm 4'11"	465 mm 1'5"	5200 mm 17'

POWERMIX PLUS

16, 18, 20 & 22m³ Compact - Twin Auger

ELEVATING FRONT CONVEYOR.

Designed around a short chassis and with Shelbourne's distinctive curved tub to speed up bale processing and mixing, the 16-22m³ Powermix Plus Express models are engineered to meet the needs of those seeking high capacity in a manoeuvrable, compact package.

THE RANGE	VOLUME	AXLE SPEC	TYRE SPEC
POWERMIX PLUS 16 SA	16m ³	SINGLE FIXED	435/50 R19.5
POWERMIX PLUS 16 TA	16m ³	TANDEM SPRUNG	385/55 R22.5
POWERMIX PLUS 18 SA	18m ³	SINGLE FIXED	435/50 R19.5
POWERMIX PLUS 18 TA	18m ³	TANDEM SPRUNG	385/55 R22.5
POWERMIX PLUS 20 SA	20m ³	SINGLE FIXED	435/50 R19.5
POWERMIX PLUS 20 TA	20m ³	TANDEM SPRUNG	385/55 R22.5
POWERMIX PLUS 22 TA	22m ³	TANDEM SPRUNG	385/55 R22.5



KEY FEATURES

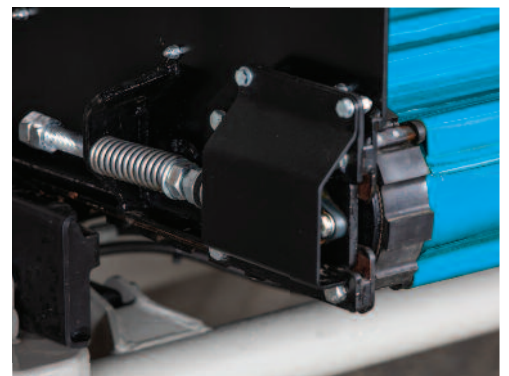
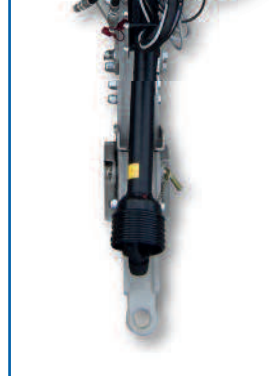
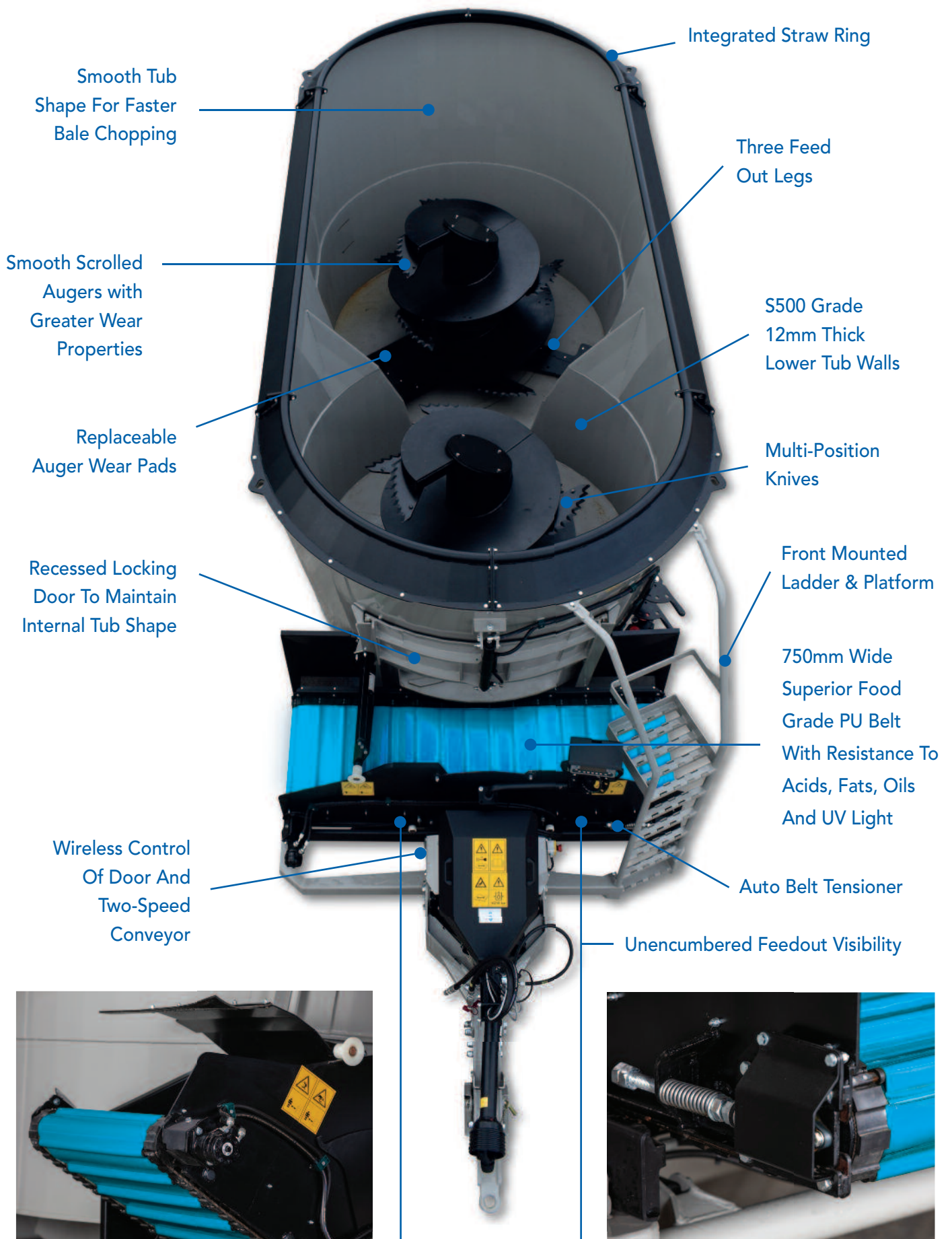

POWERMIX PLUS

16-20m³ Compact - Twin Auger - Single Axle

STANDARD FEATURES & OPTIONS

STANDARD FEATURES	16M	18M	20M
CAPACITY / LEVEL	8000 kg*	9000 kg*	10000 kg*
VOLUME / LEVEL	16m ³	18m ³	20m ³
TYRE SIZE	435/55R19.5	435/55R19.5	435/55R19.5
AXLE TYPE	SINGLE		
PTO SPEED	540 rpm	540 rpm	540 rpm
HP REQUIRED	110	120	130
UNLADEN WEIGHT	7648 kg	7680 kg	7864 kg
DOOR CONFIGURATION	FRONT CENTRE DOOR & FRONT WEBBING CONVEYOR		
DOOR OPERATION	HYDRAULIC		
HYDRAULIC BRAKES	STD	STD	STD
LED LIGHTS	STD	STD	STD
ADJUSTABLE CORNER KNIVES	STD	STD	STD
STEEL STRAW RETAINING RING	STD	STD	STD
HYDRAULIC CONTROL	HOSES DIRECT TO TRACTOR		
NUMBER OF LOAD CELLS	3	3	3
NUMBER OF AUGERS	2	2	2
NUMBER OF BLADES	14	14	14
ELEVATING FRONT CONVEYOR	STD	STD	STD
FIXED FRONT CONVEYOR	N/A	N/A	N/A
TWO SPEED GEARBOX	STD	STD	STD
AUGER MAGNET	STD	STD	STD
OPTIONS			
ELECTRIC WITH VARI SPEED CONVEYOR 2 SPD CHANGE	OPT	OPT	OPT
WIRELESS WITH VARI SPEED CONVEYOR 2 SPD CHANGE	OPT	OPT	OPT
ELECTRIC WITH VARI SPEED CONVEYOR	OPT	OPT	OPT
MANUAL VALVE HYDRAULIC CONTROL	OPT	OPT	OPT
DG400 BASIC SCALE SYSTEM	OPT	OPT	OPT
DG600 PROG. SCALE SYSTEM	OPT	OPT	OPT
REMOTE SCALE HEAD	OPT	OPT	OPT
DG REMOTE ZERO	OPT	OPT	OPT
DG GPRS DATA TRANSFER KIT	OPT	OPT	OPT
BATTERY PACK FOR SCALE	OPT	OPT	OPT
WIDE ANGLE PTO	OPT	OPT	OPT
TUNGSTEN BLADES	OPT	OPT	OPT
REAR CENTRE DOOR	OPT	OPT	OPT
CORNER REAR DOOR	N/A	N/A	N/A

DIMENSIONS

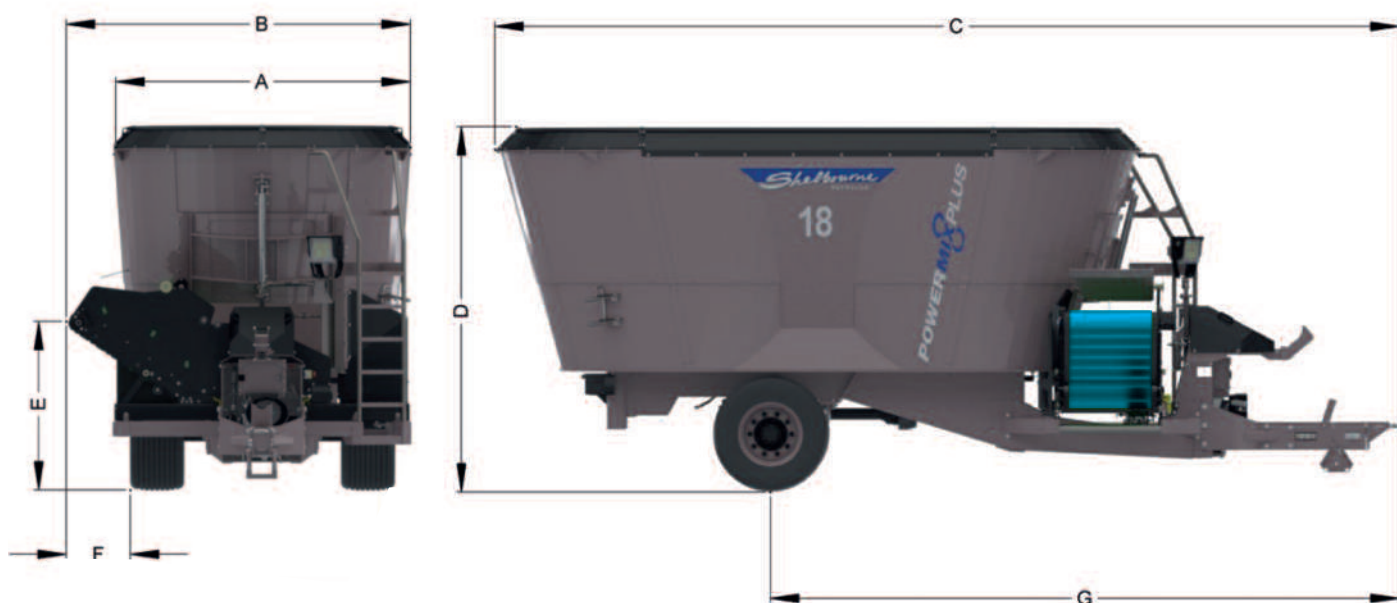
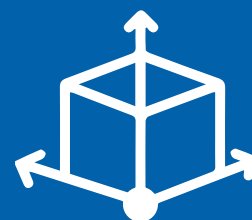

MODEL - TYRE	A	B	C	D	E	F	G
16m ³ - 435/50 R19.5	2380 mm 7'8"	2730 mm 8'9"	7355 mm 24'1"	2810 mm 9'2"	1450 mm 4'7"	463 mm 1'5"	5100 mm 16'7"
16m ³ - 385/65 R22.5	2380 mm 7'8"	2730 mm 8'9"	7355 mm 24'1"	2945 mm 9'6"	1585 mm 5'2"	489 mm 1'6"	5100 mm 16'7"
16m ³ - 235/75 R17.5	2380 mm 7'8"	2730 mm 8'9"	7355 mm 24'1"	2730 mm 8'9"	1370 mm 4'4"	402 mm 1'3"	5100 mm 16'7"
18m ³ - 435/50 R19.5	2380 mm 7'8"	2730 mm 8'9"	7355 mm 24'1"	2945 mm 9'6"	1450 mm 4'7"	463 mm 1'5"	5100 mm 16'7"
18m ³ - 385/65 R22.5	2380 mm 7'8"	2730 mm 8'9"	7355 mm 24'1"	3080 mm 10'1"	1585 mm 5'2"	489 mm 1'6"	5100 mm 16'7"
18m ³ - 235/75 R17.5	2380 mm 7'8"	2730 mm 8'9"	7355 mm 24'1"	2865 mm 9'3"	1370 mm 4'4"	402 mm 1'3"	5100 mm 16'7"
20m ³ - 435/50 R19.5	2380 mm 7'8"	2730 mm 8'9"	7355 mm 24'1"	3135 mm 10'2"	1450 mm 4'7"	463 mm 1'5"	5100 mm 16'7"
20m ³ - 385/65 R22.5	2380 mm 7'8"	2730 mm 8'9"	7355 mm 24'1"	3270 mm 10'7"	1585 mm 5'2"	489 mm 1'6"	5100 mm 16'7"
20m ³ - 235/75 R17.5	2380 mm 7'8"	2730 mm 8'9"	7355 mm 24'1"	3055 mm 10'	1370 mm 4'4"	402 mm 1'3"	5100 mm 16'7"

POWERMIX PLUS

16-22m³ Twin Auger - Tandem Axle

STANDARD FEATURES & OPTIONS

STANDARD FEATURES	16M	18M	20M	22M
CAPACITY / LEVEL	8000 kg*	9000 kg*	10000 kg*	11000 kg*
VOLUME / LEVEL	16m ³	18m ³	20m ³	22m ³
TYRE SIZE	385/55R22.5	385/55R22.5	385/55R22.5	385/55R22.5
AXLE TYPE	TANDEM SPRUNG			
PTO SPEED	540 rpm	540 rpm	540 rpm	540 rpm
HP REQUIRED	110	120	130	140
UNLADEN WEIGHT	8308 kg	8340 kg	8524 kg	8637 kg
DOOR CONFIGURATION	FRONT CENTRE DOOR AND FRONT WEBBING CONVEYOR			
DOOR OPERATION	HYDRAULIC			
HYDRAULIC BRAKES	STD	STD	STD	STD
LED LIGHTS	STD	STD	STD	STD
ADJUSTABLE CORNER KNIVES	STD	STD	STD	STD
STEEL STRAW RETAINING RING	STD	STD	STD	STD
HYDRAULIC CONTROL	HOSES DIRECT TO TRACTOR			
NUMBER OF LOAD CELLS	3	3	3	3
NUMBER OF AUGERS	2	2	2	2
NUMBER OF BLADES	14	14	14	14
TWO SPEED GEARBOX	STD	STD	STD	STD
ELEVATING FRONT CONVEYOR	STD	STD	STD	STD
FIXED FRONT CONVEYOR	N/A	N/A	N/A	N/A
AUGER MAGNET	STD	STD	STD	STD
OPTIONS				
ELECTRIC CONTROL WITH VARI SPEED CONVEYOR / 2 SPD CHANGE	OPT	OPT	OPT	OPT
WIRELESS CONTROL WITH VARI SPEED CONVEYOR / 2 SPD CHANGE	OPT	OPT	OPT	OPT
ELECTRIC CONTROL WITH VARI SPEED CONVEYOR	OPT	OPT	OPT	OPT
DG400 BASIC SCALE SYSTEM	OPT	OPT	OPT	OPT
DG600 PROG. SCALE SYSTEM	OPT	OPT	OPT	OPT
REMOTE SCALE HEAD	OPT	OPT	OPT	OPT
DG REMOTE ZERO	OPT	OPT	OPT	OPT
DG GPRS DATA TRANSFER KIT	OPT	OPT	OPT	OPT
BATTERY PACK FOR SCALE	OPT	OPT	OPT	OPT
WIDE ANGLE PTO	OPT	OPT	OPT	OPT
TUNGSTEN BLADES	OPT	OPT	OPT	OPT
REAR CENTRE DOOR	OPT	OPT	OPT	OPT
CORNER REAR DOOR	N/A	N/A	N/A	N/A
AIR BRAKES	OPT	OPT	OPT	OPT
STEERING AXLE (HYD BRAKES)	OPT	OPT	OPT	OPT
STEERING AXLE (AIR BRAKES)	OPT	OPT	OPT	OPT

DIMENSIONS

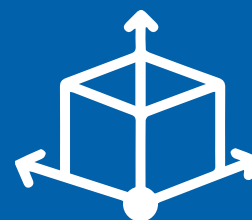

MODEL - TYRE	A	B	C	D	E	F	G
16m ³ - 385/55 R22.5	2380 mm 7'8"	2730 mm 8'9"	7355 mm 24'1"	2925 mm 9'5"	1565 mm 5'1"	489 mm 1'6"	5100 mm 16'7"
16m ³ - 385/55 R19.5	2380 mm 7'8"	2730 mm 8'9"	7355 mm 24'1"	2862 mm 9'3"	1502 mm 4'9"	489 mm 1'6"	5100 mm 16'7"
18m ³ - 385/55 R22.5	2380 mm 7'8"	2730 mm 8'9"	7355 mm 24'1"	3060 mm 10'	1565 mm 5'1"	489 mm 1'6"	5100 mm 16'7"
18m ³ - 385/55 R19.5	2380 mm 7'8"	2730 mm 8'9"	7355 mm 24'1"	2997 mm 9'8"	1502 mm 4'9"	489 mm 1'6"	5100 mm 16'7"
20m ³ - 385/55 R22.5	2380 mm 7'8"	2730 mm 8'9"	7355 mm 24'1"	3250 mm 10'6"	1565 mm 5'1"	489 mm 1'6"	5100 mm 16'7"
20m ³ - 385/55 R19.5	2380 mm 7'8"	2730 mm 8'9"	7355 mm 24'1"	3187 mm 10'4"	1502 mm 4'9"	489 mm 1'6"	5100 mm 16'7"
22m ³ - 385/55 R22.5	2380 mm 7'8"	2730 mm 8'9"	7355 mm 24'1"	3428 mm 11'2"	1565 mm 5'1"	489 mm 1'6"	5100 mm 16'7"
22m ³ - 385/55 R19.5	2380 mm 7'8"	2730 mm 8'9"	7355 mm 24'1"	3365 mm 11'	1502 mm 4'9"	489 mm 1'6"	5100 mm 16'7"

POWERMIX PLUS

22, 24, 28 & 30m³ Wide Body - Twin Auger

FOR THE MOST DEMANDING USERS.

With a short chassis for manoeuvrability and a curved tub shape for more efficient bale processing and faster mixing times, the Powermix Plus Wide Body is the flagship of the Shelbourne Reynolds range, designed for the largest herds and most demanding users. The high capacity yet compact twin auger line now includes four flagship models, aimed at users feeding 100t or more per day.

THE RANGE	VOLUME	AXLE SPEC	TYRE SPEC
POWERMIX PLUS 22 TA	22m ³	TANDEM SPRUNG	435/50 R19.5
POWERMIX PLUS 24 TA	24m ³	TANDEM SPRUNG	435/50 R19.5
POWERMIX PLUS 28 TA	28m ³	TANDEM SPRUNG	435/50 R19.5
POWERMIX PLUS 30 TA	30m ³	TANDEM SPRUNG	435/50 R19.5



KEY FEATURES



POWERMIX PLUS

22-30m³ Wide Body

STANDARD FEATURES & OPTIONS

STANDARD FEATURES	22M	24M	28M	30M
CAPACITY / LEVEL	11000 kg*	12000 kg*	14000 kg*	15000 kg*
VOLUME / LEVEL	22m ³	24m ³	28m ³	30m ³
TYRE SIZE	435/50R19.5	435/50R19.5	435/50R19.5	435/50R19.5
AXLE TYPE	TANDEM SPRUNG			
PTO SPEED	540 rpm	540 rpm	540 rpm	540 rpm
HP REQUIRED	140	140	160	160
UNLADEN WEIGHT	10105 kg	10290 kg	11048 kg	11200 kg
DOOR CONFIGURATION	FRONT CENTRE DOOR AND FRONT WEBBING CONVEYOR			
DOOR OPERATION	HYDRAULIC	HYDRAULIC	HYDRAULIC	HYDRAULIC
HYDRAULIC BRAKES	STD	STD	STD	STD
LED LIGHTS	STD	STD	STD	STD
ADJUSTABLE CORNER KNIVES	STD	STD	STD	STD
STEEL STRAW RETAINING RING	STD	STD	STD	STD
HYDRAULIC CONTROL	HOSES DIRECT TO TRACTOR			
NUMBER OF LOAD CELLS	6	6	6	6
NUMBER OF AUGERS	2	2	2	2
NUMBER OF BLADES	14	14	18	18
TWO SPEED GEARBOX	STD	STD	STD	STD
AUGER MAGNET	STD	STD	STD	STD
ELEVATING CONVEYOR	STD	STD	STD	STD
FIXED FRONT CONVEYOR	N/A	N/A	N/A	N/A
OPTIONS				
ELECTRIC CONTROL WITH VARI SPEED CONVEYOR / 2 SPD CHANGE	OPT	OPT	OPT	OPT
WIRELESS ELECTRIC CONTROL WITH VARI SPEED CONVEYOR / 2 SPD CHANGE	OPT	OPT	OPT	OPT
MANUAL HYD VALVE CONTROL	OPT	OPT	OPT	OPT
DG400 BASIC SCALE SYSTEM	OPT	OPT	OPT	OPT
DG600 PROG. SCALE SYSTEM	OPT	OPT	OPT	OPT
DG REMOTE ZERO	OPT	OPT	OPT	OPT
DG GPRS DATA TRANSFER KIT	OPT	OPT	OPT	OPT
REMOTE SCALE HEAD	OPT	OPT	OPT	OPT
BATTERY PACK FOR SCALE	OPT	OPT	OPT	OPT
WIDE ANGLE PTO	OPT	OPT	OPT	OPT
TUNGSTEN BLADES	OPT	OPT	OPT	OPT
REAR CENTRE DOOR	N/A	N/A	N/A	N/A
CORNER REAR DOOR (LH)	OPT	OPT	OPT	OPT

* DEPENDING UPON FEED DM%

DIMENSIONS

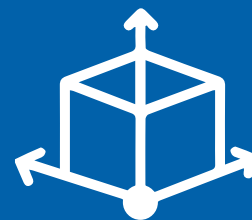

MODEL - TYRE	A	B	C	D	E	F	G
22m ³ - 435/50 R19.5	2965 mm 9'9"	2756 mm 9'1"	8259 mm 27'	2900 mm 9'6"	1555 mm 5'1"	336 mm 1'1"	5530 mm 18'2"
24m ³ - 435/50 R19.5	2965 mm 9'9"	2756 mm 9'1"	8259 mm 27'	3085 mm 10'1"	1555 mm 5'1"	336 mm 1'1"	5530 mm 18'2"
28m ³ - 435/50 R19.5	2965 mm 9'9"	2756 mm 9'1"	8259 mm 27'	3310 mm 10'10"	1555 mm 5'1"	336 mm 1'1"	5530 mm 18'2"
30m ³ - 435/50 R19.5	2965 mm 9'9"	2756 mm 9'1"	8259 mm 27'	3495 mm 11'5"	1555 mm 5'1"	336 mm 1'1"	5530 mm 18'2"



POWERMIX BIO STATIC

9-46m³ Single Or Twin Auger

DESIGNED WITH THE KNOWLEDGE GAINED FROM OVER TWENTY YEARS OF MANUFACTURING MACHINES FOR THE LIVESTOCK MARKET.

The Powermix Bio range of static mixers has been developed in conjunction with several UK biogas installation companies to meet the specific needs of anaerobic digester operators.

As a result, they are built for longevity, serviceability, mix quality and discharge consistency.

DESIGN
DELIVERY
PERFORMANCE
SERVICE



KEY FEATURES

ELECTRONIC SCALE SYSTEMS

A choice of scale systems is available, offering compatibility with existing control systems.



BOLT-IN STAINLESS STEEL TUB LINER

A bolt-in stainless steel liner is fitted to the floor and lower 1.5m tub wall. The floor section is 10mm thick and the sidewalls 8mm. This prevents corrosion and minimises wear as well as creating a clean smooth surface for minimal power requirement. The tub base is treated with a zinc paint to prevent internal rusting. The liner can be replaced in individual sections with minimal down time and no welding required.

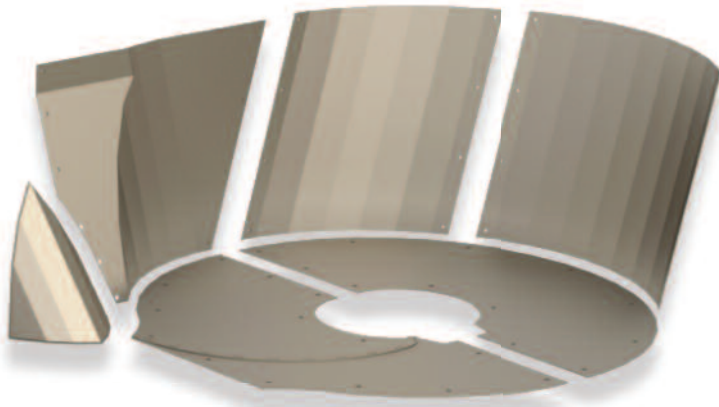

STAINLESS STEEL AUGERS

The augers are made from 15mm stainless steel with a further 10mm stainless steel wear strip welded to the outer flight. They feature three feed-out legs which help deliver material evenly to the tub discharge point.



ADJUSTABLE STANDS

The twin auger chassis consists of eight adjustable legs connected to the tub via load cells for easy installation and accurate weighing.

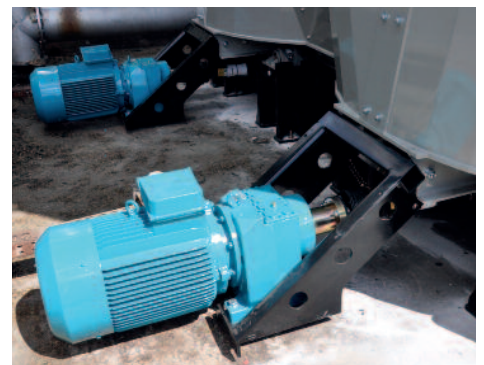

FULLY-MOUNTED INTEGRATED ELECTRIC MOTORS AND PLANETARY GEARBOXES

Electric motors and planetary gearboxes are sourced according to the machine size and mounted as a unit to the underside of the tub to facilitate a simple installation.

POWERMIX PRO TYRE OPTIONS Specification

MODEL	TYRE	HEIGHT	WIDTH
9-11 m SINGLE AUG.	425/40 B17	788 mm	425 mm
9-15 m SINGLE AUG.	385/55 R19.5	930 mm	385 mm
	385/65 R22.5	1080 mm	385 mm
16-19 m TWIN AUGER/SINGLE AXLE	435/50 R19.5	928 mm	446 mm
	18R22.5	1160 mm	455 mm
	275/75R17.5 Duals	780 mm	500 mm
16-22 m TWIN AUGER/TANDEM AXLE	385/55 R19.5	930 mm	385 mm
	385/55 R22.5	996 mm	386 mm
	385/65 R22.5	1080 mm	385 mm
WIDE BODY 22-30 m	435/50 R19.5	928 mm	446 mm

425/40 R17

For use on single auger machines to reduce height. Weight restrictions apply



385/55 R19.5

Standard tyre on all single auger models



385/55 R22.5

Standard tyre on all tandem axle machines. (16m-22m)



385/65 R22.5 SUPER SINGLE

Optional on all single auger and twin auger tandem axle machines when additional discharge height is required. Axle spacers required



POWERMIX PRO TYRE OPTIONS Specification

435/50 R19.5

Standard on twin auger single axle and all Wide Body tandem axle machines and optional on all other twin auger tandem axle machines



18R 22.5

Optional on twin auger single axle machines where a higher discharge height is required



275/75 R17.5 (DUALS)

Optional on single axle twin auger Plus machines (16-20m) when a lower machine height is required



STEERING AXLE

Optional on all twin auger tandem axle machines

POWERMIX OPTIONS

Scale & Hydraulic Controls



DG400 SCALE

- Basic scale system counts up and down
- Tare feature can be used to zero between ingredients



DG600 SCALE

- Programmable system
- Exchange data between PC and scale
- Record feed volume
- Transfer data wirelessly or by USB stick



WIRELESS REMOTE SCALE HEAD

- Mount in tractor or telehandler cab

MANUAL VALVE BLOCK HYDRAULIC CONTROL

- Allows three hydraulic services to be operated from one spool valve
- Can be mounted to an adjustable arm on the mixer or to the tractor top link bracket

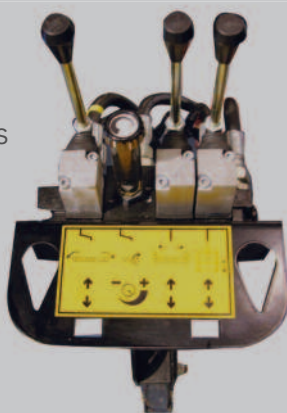

WIRELESS ELECTRIC HYDRAULIC AND TWO-SPEED CONTROL (PLUS ONLY)

- Gives precise, accurate control of all hydraulic functions including belt speed and two-speed operation



ELECTRIC HYDRAULIC CONTROLS

- Gives precise, convenient control of three hydraulic functions using one spool valve
- Convenient, easy to use hand controller
- Optional incorporated conveyor speed control



STANDARD ELECTRIC CONTROL

ELECTRIC CONTROL WITH CONVEYOR SPEED CONTROL

ELECTRIC TWO-SPEED CONTROL

- Allows electric two-speed gear change on direct coupled machines



POWERMIX AUGER SPEEDS

Specification

MODEL	2 SPEED	540 PTO INPUT	1000 PTO INPUT
SINGLE AUGER (SINGLE SPEED)	N/A	28 rpm	52 rpm
SINGLE AUGER (TWO SPEED)	LOW HIGH	16 rpm *	29 rpm 52 rpm
PRO - TWIN AUGER	LOW HIGH	11 rpm *	21 rpm 37 rpm
PLUS - COMPACT TWIN AUGER (16-22m)	LOW HIGH	16 rpm *	29 rpm 52 rpm
PLUS - WIDE BODY TWIN AUGER (22-24m)	LOW HIGH	13 rpm *	24 rpm 43 rpm
PLUS - WIDE BODY TWIN AUGER (28-30m)	LOW HIGH	12 rpm *	22 rpm 40 rpm

* NOT RECOMMENDED



REAR DOOR

- A centre-mounted rear door is available on Powermix Plus Compact models (16-22m)

CORNER REAR DOOR

- A left hand rear corner door is available for 22-30m "Wide Body" Powermix Plus models





GROUND CARE



HARVESTING



LIVESTOCK



SHELBOURNE REYNOLDS
ENGINEERING LTD.

SHEPHERDS GROVE, STANTON,
BURY ST EDMUNDS,
SUFFOLK, IP31 2AR

FIND US:



SHELBOURNE.COM